



THB Interference Suppression Film Capacitors - Class X2 Radial MKP 305 V_{AC} - Across the Line



FEATURES

- IEC 60384-14: 2013 / AMD1: 2016 grade IIIB: 85 °C, 85 % RH, 1000 h at U_{RAC}
- Material categorization: for definitions of compliance please see www.vishay.com/doc?99912



RoHS
COMPLIANT
HALOGEN
FREE
GREEN
(5-2008)

APPLICATIONS

For industrial across the line X2 applications.
See also application note: www.vishay.com/doc?28153

QUICK REFERENCE DATA	
Rated capacitance range	1 µF to 20 µF (preferred values according to E12)
Capacitance tolerance	± 20 %; ± 10 %
Climatic testing class according to IEC 60068-1	40 / 105 / 56B
Rated AC voltage	305 V _{AC} ; 50 Hz to 60 Hz
Permissible DC voltage	630 V _{DC} at 105 °C
Maximum application temperature	105 °C
Reference standards	EC 60384-14:2013 IEC 60384-14:2013 / AMD1:2016 EN 60384-14 IEC 60065 requires passive flammability class B: for volume ≥ 1750 mm ³ UL 60384-14 (2 nd edition) CSA-E60384-1:14 (3 rd edition)
Dielectric	Polypropylene film
Electrodes	Metallized
Construction	Mono construction
Encapsulation	Plastic case, epoxy resin sealed, flame retardant UL-class 94 V-0
Terminals	Tinned wire
Marking	C-value; tolerance; rated voltage; sub-class; manufacturer's type designation; code for dielectric material; manufacturer location, year and week; manufacturer's logo or name; safety approvals

Note

- For more detailed data and test requirements, contact rfi@vishay.com

DIMENSIONS in millimeters	
2 PINS	4 PINS
<p>P1 ± 0.4 - PCM 27.5 mm P1 ± 0.5 - PCM ≥ 37.5 mm</p>	<p>P1 ± 0.5 P2 ± 0.5</p>

Note

- Ø dt ± 10 % of standard diameter specified



COMPOSITION OF CATALOG NUMBER

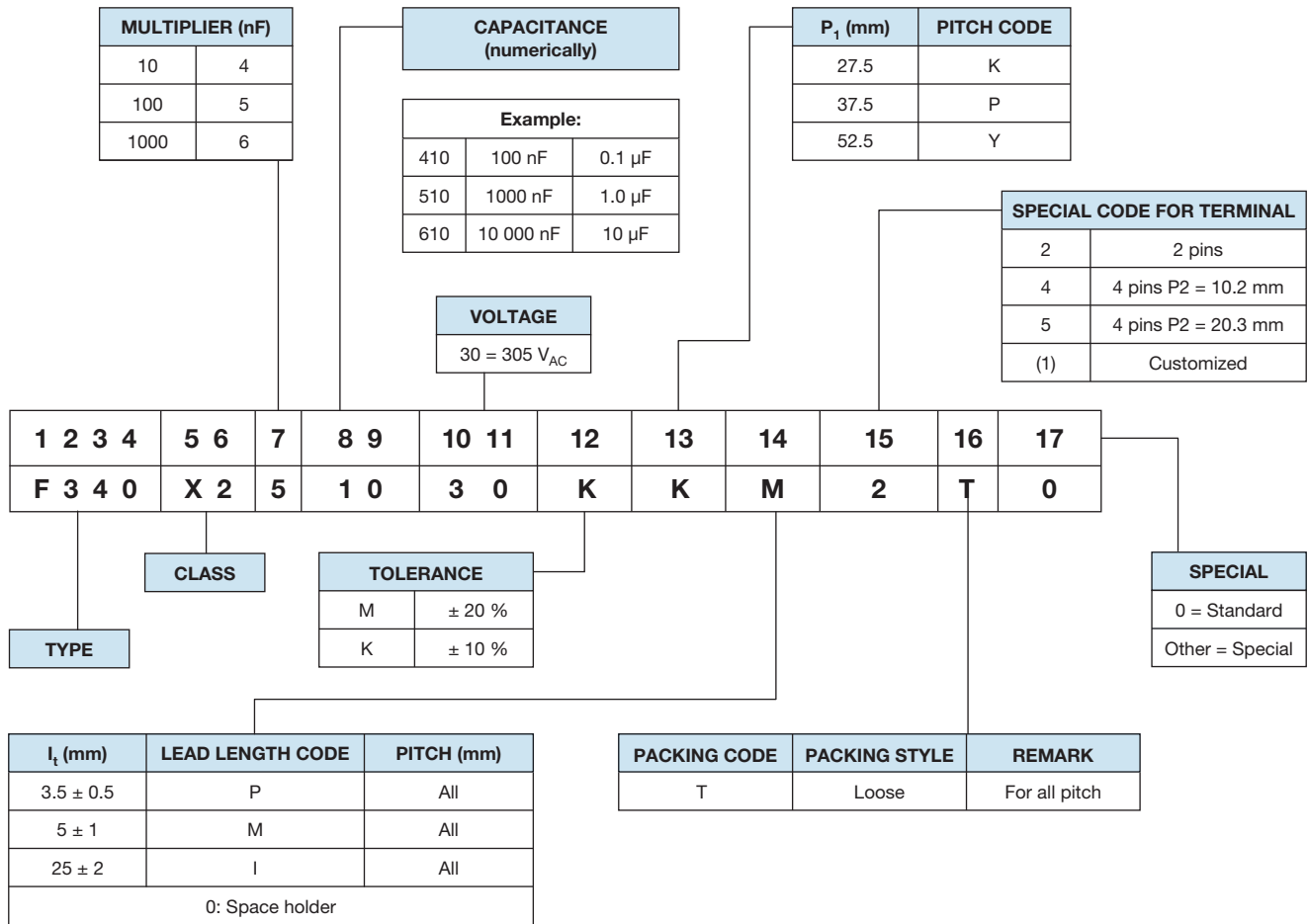

Note

- For detailed tape specifications refer to packaging information www.vishay.com/doc?28139



SPECIFIC REFERENCE DATA	
DESCRIPTION	VALUE
Rated AC voltage (U_{RAC})	305 V _{AC}
Permissible DC voltage (U_{RDC})	630 V _{DC}
Tangent of loss angle:	At 1 kHz At 10 kHz
1 μ F < C \leq 4.7 μ F	$\leq 10 \times 10^{-4}$ $\leq 35 \times 10^{-4}$
4.7 μ F < C \leq 12 μ F	$\leq 20 \times 10^{-4}$ -
C > 12 μ F	$\leq 40 \times 10^{-4}$ -
Rated voltage pulse slope (du/dt) _R at 435 V _{DC}	
Pitch = 27.5 mm	100 V/ μ s
Pitch = 37.5 mm	50 V/ μ s
Pitch = 52.5 mm	15 V/ μ s
RC between leads, for C > 0.33 μ F at 100 V; 1 min	> 5000 s
R between leads and case; 100 V; 1 min	> 30 000 M Ω
Withstanding (DC) voltage (cut off current 10 mA) ⁽¹⁾ ; rise time \leq 1000 V/s:	
1 μ F \leq C \leq 12 μ F	2200 V; 1 min
> 12 μ F	1800 V; 1 min
Withstanding (AC) voltage between leads and case	2110 V; 1 min

Note



⁽¹⁾ See "Voltage Proof Test for Metalized Film Capacitors": www.vishay.com/doc?28169

ELECTRICAL DATA AND ORDERING INFORMATION								
U _{RAC} (V)	CAP. (μ F)	DIMENSIONS ⁽²⁾ w x h x l (mm)	MASS (g)	CATALOG NUMBER F340X2... AND PACKAGING				
				LOOSE IN BOX				
				SHORT LEADS ⁽¹⁾			LONG LEADS ⁽¹⁾	
				l _t = 3.5 mm \pm 0.5 mm	l _t = 5.0 mm \pm 1.0 mm	SPQ	l _t = 25.0 mm \pm 2.0 mm	SPQ
PITCH = 27.5 mm \pm 0.4 mm; d_t = 0.80 mm \pm 0.08 mm; C-TOL. = \pm 20 %								
1.0	15.0 x 25.0 x 32.0	13.9	51030MKP2T0	51030MKM2T0	115	51030MKI2T0	95	
1.5	15.0 x 25.0 x 32.0	12.9	51530MKP2T0	51530MKM2T0	65	51530MKI2T0	95	
2.2	18.0 x 28.0 x 32.0	17.7	52230MKP2T0	52230MKM2T0	65	52230MKI2T0	80	
3.3	21.0 x 31.0 x 32.0	23.2	53330MKP2T0	53330MKM2T0	65	53330MKI2T0	65	
4.7	22.0 x 38.0 x 32.0	28.4	54730MKP2T0	54730MKM2T0	60	54730MKI2T0	60	
PITCH = 37.5 mm \pm 0.5 mm; d_t = 1.0 mm \pm 0.1 mm; C-TOL. = \pm 20 %								
6.8	21.5 x 38.5 x 42.0	33.1	56830MPP*T0	56830MMP*T0	91	56830MPI*T0	91	
10	30.0 x 45.0 x 42.0	55.3	61030MPP*T0	61030MMP*T0	63	61030MPI*T0	63	
PITCH = 52.5 mm \pm 0.5 mm; d_t = 1.2 mm \pm 0.12 mm; C-TOL. = \pm 20 %								
15	30.0 x 45.0 x 57.5	73.5	61530MYP*T0	61530MYM*T0	45	61530MYI*T0	45	
20	35.0 x 50.0 x 57.5	94.9	62230MYP*T0	62230MYM*T0	40	62230MYI*T0	40	
PITCH = 27.5 mm \pm 0.4 mm; d_t = 0.80 mm \pm 0.08 mm; C-TOL. = \pm 10 %								
1.0	15.0 x 25.0 x 32.0	13.7	51030KKP2T0	51030KKM2T0	95	51030KKI2T0	95	
1.2	15.0 x 25.0 x 32.0	13.1	51230KKP2T0	51230KKM2T0	95	51230KKI2T0	95	
1.5	15.0 x 25.0 x 32.0	12.6	51530KKP2T0	51530KKM2T0	95	51530KKI2T0	95	
1.8	18.0 x 28.0 x 32.0	17.8	51830KKP2T0	51830KKM2T0	80	51830KKI2T0	80	
2.2	18.0 x 28.0 x 32.0	17.0	52230KKP2T0	52230KKM2T0	80	52230KKI2T0	80	
2.7	21.0 x 31.0 x 32.0	23.4	52730KKP2T0	52730KKM2T0	65	52730KKI2T0	65	
3.3	21.0 x 31.0 x 32.0	22.1	53330KKP2T0	53330KKM2T0	65	53330KKI2T0	65	
3.9	22.0 x 38.0 x 32.0	28.8	53930KKP2T0	53930KKM2T0	60	53930KKI2T0	60	
4.7	22.0 x 38.0 x 32.0	27.5	54730KKP2T0	54730KKM2T0	60	54730KKI2T0	60	
PITCH = 37.5 mm \pm 0.5 mm; d_t = 1.0 mm \pm 0.1 mm; C-TOL. = \pm 10 %								
5.6	21.5 x 38.5 x 42.0	33.8	55630KPP*T0	55630KPM*T0	91	55630KPI*T0	91	
6.8	21.5 x 38.5 x 42.0	31.6	56830KPP*T0	56830KPM*T0	91	56830KPI*T0	91	
8.2	30.0 x 45.0 x 42.0	57.4	58230KPP*T0	58230KPM*T0	63	58230KPI*T0	63	
10	30.0 x 45.0 x 42.0	53.2	61030KPP*T0	61030KPM*T0	63	61030KPI*T0	63	
12	30.0 x 45.0 x 42.0	49.3	61230KPP*T0	61230KPM*T0	63	61230KPI*T0	63	
PITCH = 52.5 mm \pm 0.5 mm; d_t = 1.2 mm \pm 0.12 mm; C-TOL. = \pm 10 %								
15	30.0 x 45.0 x 57.5	71.2	61530KYP*T0	61530KYM*T0	45	61530KYI*T0	45	
18	35.0 x 50.0 x 57.5	96.4	61830KYP*T0	61830KYM*T0	40	61830KYI*T0	40	
20	35.0 x 50.0 x 57.5	91.9	62230KYP*T0	62230KYM*T0	40	62230KYI*T0	40	

Notes

- SPQ = Standard Packing Quantity
- ⁽¹⁾ Change the "*" symbol with special code for the terminals
- ⁽²⁾ For tolerances see chapter "Dimensions Tolerances"



APPROVALS				
SAFETY APPROVALS X2	VOLTAGE	VALUE	FILE NUMBERS	LINK
EN 60384-14 (ENEC) (= IEC 60384-14 ed-4 (2013))	305 V _{AC}	1 μF to 20 μF	Pending	
UL 60384-14 (2 nd edition)	305 V _{AC}	1 μF to 20 μF	Pending	
CSA-E60384-1:14 (3 rd edition)	305 V _{AC}	1 μF to 20 μF	Pending	
CQC	305 V _{AC}	1 μF to 20 μF	Pending	
CB-test certificate	305 V _{AC}	1 μF to 20 μF	Pending	
The ENEC-approval together with the CB-certificate replace all national marks of the following countries (they have already signed the ENEC-agreement): Austria; Belgium; Czech Republic; Denmark; Finland; France; Germany; Greece; Hungary; Ireland; Italy; Luxembourg; Netherlands; Norway; Portugal; Slovenian; Spain; Sweden, Switzerland, and United Kingdom.				
  				

MOUNTING

Normal Use

The capacitor unit is designed for mounting on printed-circuit boards. The capacitors packed in bandoliers are designed for mounting in printed-circuit boards by means of automatic insertion machines.

For detailed tape specifications refer to packaging information www.vishay.com/docs?28139

Specific Method of Mounting to Withstand Vibration and Shock

The capacitor unit is designed for mounting on a printed-circuit board. In order to withstand vibration and shock tests, it must be ensured that the stand-off pips are in good contact with the printed-circuit board. The capacitor shall be mechanically fixed by the leads and the body clamped.

Dimensions Tolerances

For the maximum product dimensions for length ($l_{max.}$), width ($w_{max.}$), and height ($h_{max.}$) use the following tolerances:

$$l_{max.} = l + \Delta l, w_{max.} = w + \Delta w, \text{ and } h_{max.} = h + \Delta h$$

- For products with pitch = 27.5 mm, $\Delta w = \Delta l = \Delta h = 0.7$ mm
- For products with pitch = 37.5 mm, $\Delta w = \Delta l = \Delta h = 0.7$ mm
- For products with pitch = 52.5 mm, $\Delta w = \Delta l = \Delta h = 1.0$ mm

For the minimum product dimensions for length ($l_{min.}$), width ($w_{min.}$) and height ($h_{min.}$) following tolerances of the components are valid:

$$l_{min.} = l - \Delta l, w_{min.} = w - \Delta w, \text{ and } h_{min.} = h - \Delta h$$

- For products with pitch = 27.5 mm, $\Delta w = \Delta l = \Delta h = 1.0$ mm
- For products with pitch = 37.5 mm, $\Delta w = \Delta l = \Delta h = 1.0$ mm
- For products with pitch = 52.5 mm, $\Delta w = \Delta l = \Delta h = 1.5$ mm

Space Requirements for Printed-Circuit Board

For product height with seating plane as given by "IEC 60717" as reference.

For 2 pins:

The maximum space for length ($l_{max.}$), width ($w_{max.}$), and height ($h_{max.}$) of film capacitors to take in account on the printed-circuit board is shown in the drawings.

- For products with pitch = 27.5 mm, $\Delta w = \Delta l = \Delta h = 0.7$ mm
- For products with pitch = 37.5 mm, $\Delta w = \Delta l = \Delta h = 0.7$ mm
- For products with pitch = 52.5 mm, $\Delta w = \Delta l = \Delta h = 1.0$ mm

Eccentricity defined as in drawing. The maximum eccentricity is smaller than or equal to the lead diameter of the product concerned.

The maximum length and width of film capacitors is shown in the figure:

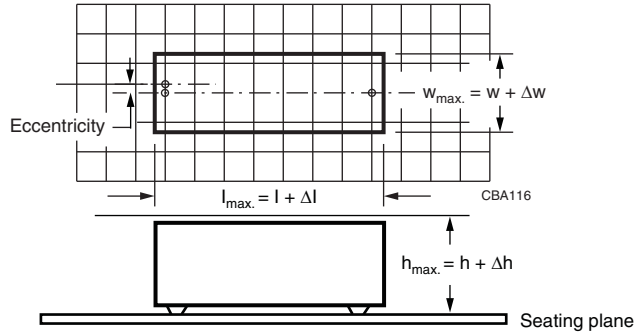

For 4 pins:

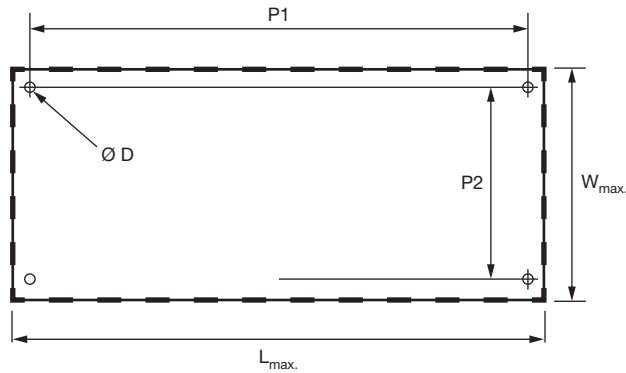

P1 (mm)	L _{max.} (mm)	W _{max.} (mm)	Ø D (mm)	Δh (mm)
37.5	l + 1.5	w + 1.8	1.5	0.7
52.5	l + 1.8	w + 2.0	1.7	1.0

SOLDERING CONDITIONS

For general soldering conditions and wave soldering profile we refer to the document “Soldering Guidelines for Film Capacitors”: www.vishay.com/doc?28171

STORAGE TEMPERATURE

T_{stg} = -25 °C to +35 °C with RH maximum 75 % without condensation

RATINGS AND CHARACTERISTICS REFERENCE CONDITIONS

Unless otherwise specified, all electrical values apply to an ambient temperature of 23 °C ± 1°C, an atmospheric pressure of 86 kPa to 106 kPa and a relative humidity of 50 % ± 2 %.

For reference testing, a conditioning period shall be applied over 96 hours ± 4 hours by heating the products in a circulating air oven at the rated temperature and a relative humidity not exceeding 20 %.



CHARACTERISTICS

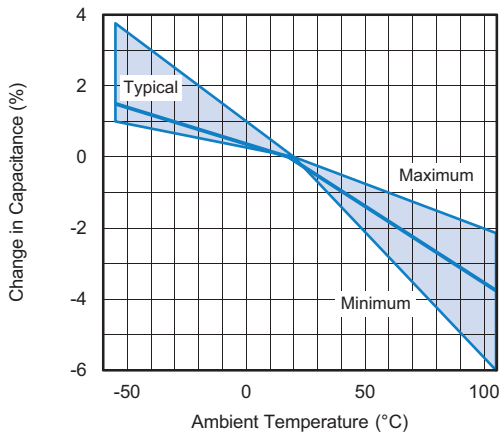

Capacitance as a function of ambient temperature (typical curve)

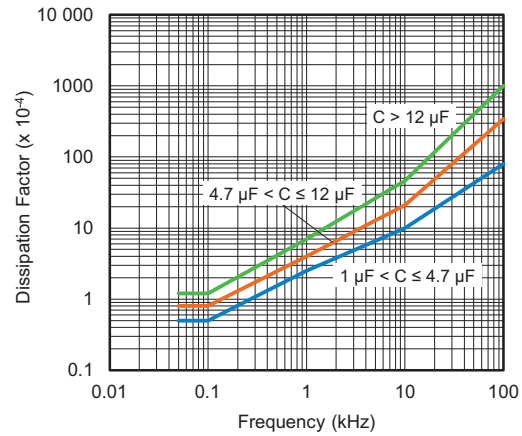

Tangent of loss angle as a function of frequency (typical curve)

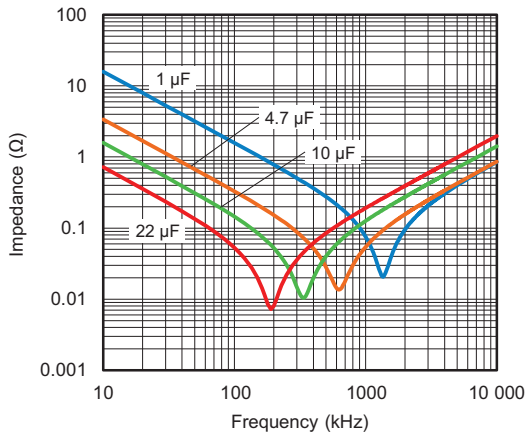

Impedance as a function of frequency (typical curve)

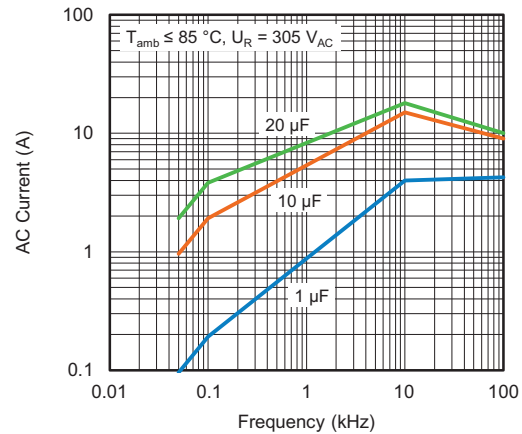

Max. RMS current as a function of frequency

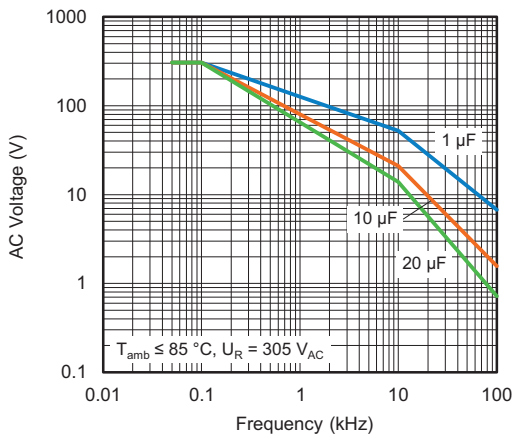

Max. RMS voltage as a function of frequency

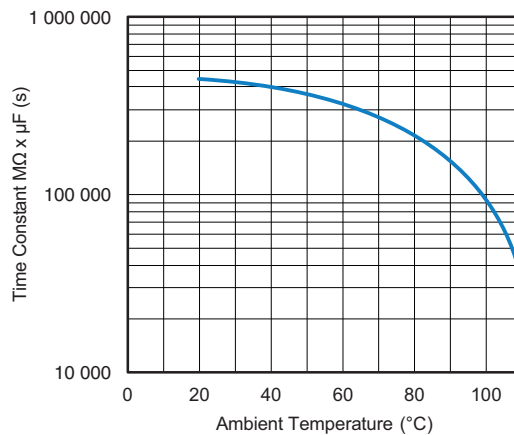

Insulation resistance as a function of ambient temperature (typical curve)

**APPLICATION NOTES**

- For X2 electromagnetic interference suppression in standard across the line applications (50 Hz / 60 Hz) with a maximum of 305 V_{AC} rated voltage including fluctuation of the mains. It is recommended to use these components in a mains with maximum nominal voltage of 240 V_{AC}. Higher continuous applied voltages will shorten the life time
- For series impedance applications we refer to application note www.vishay.com/doc?28153
- To ensure withstanding high humidity requirements in the application the epoxy adhesion at the leads shall not be damaged. Therefore the leads may not be damaged or not be bent before soldering
- For capacitors connected in parallel, normally the proof voltage and possibly the rated voltage must be reduced. For information depending of the capacitance value and the number of parallel connections contact: rfi@vishay.com
- These capacitors are not intended for continuous pulse applications. For these situations capacitors of the AC and pulse programs must be used
- The maximum ambient temperature must not exceed 105 °C
- Rated voltage pulse slope:
if the pulse voltage is lower than the rated voltage, the values of the specific reference data can be multiplied by $435 V_{DC}$ and divided by the applied voltage



INSPECTION REQUIREMENTS

General Notes

Sub-clause numbers of tests and performance requirements refer to the “Sectional Specification, Publication IEC 60384-14 ed-4 (2013) and Specific Reference Data”.

INSPECTION REQUIREMENTS		
SUB-CLAUSE NUMBER AND TEST	CONDITIONS	PERFORMANCE REQUIREMENTS
SUB-GROUP C1A PART OF SAMPLE OF SUB-GROUP C1		
4.1 Dimensions (detail)		As specified in chapters “General Data” of this specification
Initial measurements	Capacitance Tangent of loss angle: for $C \leq 1 \mu\text{F}$ at 10 kHz for $C > 1 \mu\text{F}$ at 1 kHz	
4.3 Robustness of terminations	Tensile: load 10 N; 10 s Bending: load 5 N; 4 x 90°	No visible damage
4.4 Resistance to soldering heat	No pre-drying Method: 1A Solder bath: 280 °C ± 5 °C Duration: 10 s	
4.19 Component solvent resistance	Isopropylalcohol at room temperature Method: 2 Immersion time: 5 min ± 0.5 min Recovery time: min. 1 h, max. 2 h	
4.4.2 Final measurements	Visual examination	No visible damage Legible marking
	Capacitance	$ \Delta C/C \leq 5\%$ of the value measured initially
	Tangent of loss angle	Increase of $\tan \delta$: ≤ 0.008 for: $C \leq 1 \mu\text{F}$ or ≤ 0.005 for: $C > 1 \mu\text{F}$ Compared to values measured initially
	Insulation resistance	As specified in section “Insulation Resistance” of this specification
SUB-GROUP C1B PART OF SAMPLE OF SUB-GROUP C1		
Initial measurements	Capacitance Tangent of loss angle: for $C \leq 1 \mu\text{F}$ at 10 kHz for $C > 1 \mu\text{F}$ at 1 kHz	
4.20 Solvent resistance of the marking	Isopropyl alcohol at room temperature Method: 1 Rubbing material: cotton wool Immersion time: 5 min ± 0.5 min	No visible damage Legible marking
4.6 Rapid change of temperature	$\theta A = -40\text{ °C}$ $\theta B = +105\text{ °C}$ 5 cycles Duration $t = 30\text{ min}$	
4.6.1 Inspection	Visual examination	No visible damage
4.7 Vibration	Mounting: see section “Mounting” of this specification Procedure B4: Frequency range: 10 Hz to 55 Hz Amplitude: 0.75 mm or Acceleration 98 m/s ² (whichever is less severe) Total duration 6 h	



INSPECTION REQUIREMENTS		
SUB-CLAUSE NUMBER AND TEST	CONDITIONS	PERFORMANCE REQUIREMENTS
4.7.2 Final inspection	Visual examination	No visible damage
4.9 Shock	Mounting: see section "Mounting" for more information Pulse shape: half sine Acceleration: 490 m/s ² Duration of pulse: 11 ms	
4.9.2 Final measurements	Visual examination	No visible damage
	Capacitance	$ \Delta C/C \leq 5\%$ of the value measured initially
	Tangent of loss angle	Increase of $\tan \delta$: ≤ 0.008 for: $C \leq 1 \mu\text{F}$ or ≤ 0.005 for: $C > 1 \mu\text{F}$ Compared to values measured initially
	Insulation resistance	As specified in section "Insulation Resistance" of this specification
SUB-GROUP C1 COMBINED SAMPLE OF SPECIMENS OF SUB-GROUPS C1A AND C1B		
4.11 Climatic sequence		
4.11.1 Initial measurements	Capacitance Measured in 4.4.2 and 4.9.2	
	Tangent of loss angle: measured initially in C1A and C1B	
4.11.2 Dry heat	Temperature: 105 °C	
4.11.3 Damp heat cyclic Test Db First cycle	Duration: 16 h	
4.11.4 Cold	Temperature: -40 °C	
4.11.5 Damp heat cyclic Test Db remaining cycles	Duration: 2 h	
4.11.6 Final measurements	Visual examination	No visible damage Legible marking
	Capacitance	$ \Delta C/C \leq 5\%$ of the value measured in 4.11.1.
	Tangent of loss angle	Increase of $\tan \delta$: ≤ 0.008 for: $C \leq 1 \mu\text{F}$ or ≤ 0.005 for: $C > 1 \mu\text{F}$ Compared to values measured in 4.11.1
	Voltage proof 1350 V _{DC} ; 1 min between terminations	No permanent breakdown or flash-over
	Insulation resistance	$\geq 50\%$ of values specified in section "Insulation Resistance" of this specification



INSPECTION REQUIREMENTS		
SUB-CLAUSE NUMBER AND TEST	CONDITIONS	PERFORMANCE REQUIREMENTS
4.12 Damp heat steady state	56 days, 40 °C, 90 % to 95 % RH, no load	
4.12.1 Initial measurements	Capacitance Tangent of loss angle at 1 kHz	
4.12.3 Final measurements	Visual examination	No visible damage Legible marking
	Capacitance	$ \Delta C/C \leq 5\%$ of the value measured in 4.12.1.
	Tangent of loss angle	Increase of $\tan \delta$: ≤ 0.008 for: $C \leq 1 \mu\text{F}$ or ≤ 0.005 for: $C > 1 \mu\text{F}$ Compared to values measured in 4.12.1.
	Voltage proof 1350 V _{DC} ; 1 min between terminations	No permanent breakdown or flash-over
	Insulation resistance	$\geq 50\%$ of values specified in section "Insulation Resistance" of this specification
SUB-GROUP C2A		
4.12A Damp heat steady state with load	85 °C, 85 % RH, load: 305 V _{AC} Duration: 1000 h	
4.12.1A Initial measurements	Capacitance Tangent of loss angle: for $C \leq 1 \mu\text{F}$ at 10 kHz for $C > 1 \mu\text{F}$ at 1 kHz	
4.12.3A Final measurements	Visual examination	No visible damage Legible marking
	Capacitance	$ \Delta C/C \leq 10\%$ of the value measured in 4.12.1A.
	Tangent of loss angle	Increase of $\tan \delta$: ≤ 0.0240 for: $C \leq 1 \mu\text{F}$ at 10 kHz > 0.0180 for: $C > 1 \mu\text{F}$ at 1 kHz Compared to values measured in 4.12.1A.
	Voltage proof 1350 V _{DC} ; 1 min between terminations	No permanent breakdown or flash-over
	Insulation resistance	$\geq 50\%$ of values specified in section "Insulation Resistance" of this specification



INSPECTION REQUIREMENTS		
SUB-CLAUSE NUMBER AND TEST	CONDITIONS	PERFORMANCE REQUIREMENTS
SUB-GROUP C3		
4.13.1 Initial measurements	Capacitance Tangent of loss angle: for $C \leq 1 \mu\text{F}$ at 10 kHz for $C > 1 \mu\text{F}$ at 1 kHz	
4.13 Impulse voltage	3 successive impulses, full wave, peak voltage: X2: 2.5 kV for $C \leq 1 \mu\text{F}$ X2: 2.5 kV \sqrt{C} for $C > 1 \mu\text{F}$ Max. 24 pulses	No self healing, breakdowns, or flash-over
4.14 Endurance	Duration: 1000 h 1.25 x U_{RAC} at 105 °C Once in every hour the voltage is increased to 1000 V_{RMS} for 0.1 s	
4.14.7 Final measurements	Visual examination Capacitance Tangent of loss angle Voltage proof 1350 V_{DC} ; 1 min between terminations 2120 V_{AC} ; 1 min between terminations and case Insulation resistance	No visible damage Legible marking $ \Delta C/C \leq 10\%$ compared to values measured in 4.13.1. Increase of $\tan \delta$: ≤ 0.008 for: $C \leq 1 \mu\text{F}$ or ≤ 0.005 for: $C > 1 \mu\text{F}$ Compared to values measured in 4.13.1 No permanent breakdown or flash-over $\geq 50\%$ of values specified in section "Insulation Resistance" of this specification
SUB-GROUP C4		
4.15 Charge and discharge	10 000 cycles Charged to 435 V_{DC} Discharge resistance: $R = \frac{435 V_{DC}}{1.25 \times C (du/dt)}$	
4.15.1 Initial measurements	Capacitance Tangent of loss angle: for $C \leq 1 \mu\text{F}$ at 10 kHz for $C > 1 \mu\text{F}$ at 1 kHz	
4.15.3 Final measurements	Capacitance Tangent of loss angle Insulation resistance	$ \Delta C/C \leq 10\%$ compared to values measured in 4.15.1. Increase of $\tan \delta$: ≤ 0.008 for: $C \leq 1 \mu\text{F}$ or ≤ 0.005 for: $C > 1 \mu\text{F}$ Compared to values measured in 4.15.1 $\geq 50\%$ of values specified in section "Insulation Resistance" of this specification

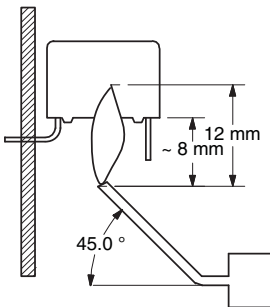

INSPECTION REQUIREMENTS		
SUB-CLAUSE NUMBER AND TEST	CONDITIONS	PERFORMANCE REQUIREMENTS
SUB-GROUP C5		
4.16 Radio frequency characteristic	Resonance frequency	≥ 0.9 times the value as specified in section "Resonant Frequency" of this specification
SUB-GROUP C6		
4.17 Passive flammability Class B for volume > 1750 mm ³ Class C for volume ≤ 1750 mm ³	Bore of gas jet: Ø 0.5 mm Fuel: butane Test duration for actual volume V in mm ³ : V ≤ 250: 5 s 250 < V ≤ 500: 10 s 500 < V ≤ 1750: 20 s V > 1750: 60 s One flame application: 	After removing test flame from capacitor, the capacitor must not continue to burn for more than 30 s for V ≤ 1750 mm ³ and 10 s for V > 1750 mm ³ . No burning particle must drop from the sample.
SUB-GROUP C7		
4.18 Active flammability	20 cycles of 2.5 kV discharges on the test capacitor connected to U _{RAC}	The cheese cloth around the capacitors shall not burn with a flame. No electrical measurements are required.